

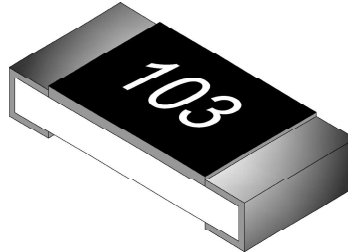

QR Series Automotive Chip Resistor Product Specifications

Document No.	S-10-12-20-07
Revision Date	2020/05/06
Page No.	1/13

■ Automotive Chip Resistor — QR Series



■ Application

- Automotive electronics
- Navigation equipment, TPMS
- Heating, Ventilating and Air conditioning
- Indoor lighting, Central door locking, Wiper module

■ Features

- Small size and light weight
- Reliability, high quality
- CCD visual quality inspection
- AEC-Q200 Compliant

■ Parts Number Explanation

■ Example:

QR	0612	L	10R0	P	05	Z
Product Type	Size (Inch)	Resistor Tolerance	Resistor Value	Package	Quantity	Optional
QR: AEC-Q200 Compliance	0402 0603 0805 1206 1210 1812 2010 2512	B : ±0.1% D : ±0.5% F : ±1% G : ±2% J : ±5%	0R=0R00 10mR=R010 100mR=R100 1R=1R00 10R=10R0 100R=100R 1K=1K00 1M=1M00	P : Paper Taping (0603~1210) Q : Paper Taping (0402) E : Embossed Taping	04 : 4000PCS 05 : 5000PCS 10 : 10000PCS 40 : 40000PCS 50 : 50000PCS	Z : Default code 7 : TCR ± 200ppm



QR Series Automotive Chip Resistor Product Specifications

Document No.	S-10-12-20-07
Revision Date	2020/05/06
Page No.	2/13

Standard Electrical Specifications

Item Type	Rated Power at 70℃	Max Working Voltage	Max Overload Voltage	T.C.R. (PPM/℃)	Resistance Range		
					B(±0.1%) D(±0.5%)	F(±1%) G(±2%)	J(±5%) K(±10%)
QR0402	0.063 W	50V	100V	±400	-	1Ω ≤ R < 10Ω	
				±100	10Ω ≤ R ≤ 1MΩ	10Ω ≤ R ≤ 10MΩ	
QR0603	0.1 W	75V	150V	±400	-	1Ω ≤ R < 10Ω	
				±100	10Ω ≤ R ≤ 1MΩ	10Ω ≤ R ≤ 10MΩ	
QR0805	0.125 W	150V	300V	±400	-	1Ω ≤ R < 10Ω	
				±100	10Ω ≤ R ≤ 1MΩ	10Ω ≤ R ≤ 10MΩ	
QR1206	0.25 W	200V	400V	±400	-	1Ω ≤ R < 10Ω	
				±100	10Ω ≤ R ≤ 1MΩ	10Ω ≤ R ≤ 10MΩ	
QR1210	0.5 W			±400	-	1Ω ≤ R < 10Ω	
				±100	10Ω ≤ R ≤ 1MΩ	10Ω ≤ R ≤ 10MΩ	
QR1812	0.75 W			±400	-	1Ω ≤ R < 10Ω	
				±100	10Ω ≤ R ≤ 1MΩ	10Ω ≤ R ≤ 10MΩ	
QR2010	0.75 W			±400	-	1Ω ≤ R < 10Ω	
				±100	10Ω ≤ R ≤ 1MΩ	10Ω ≤ R ≤ 10MΩ	
QR2512	1 W			±400	-	1Ω ≤ R < 10Ω	
				±100	10Ω ≤ R ≤ 1MΩ	10Ω ≤ R ≤ 10MΩ	

- For non-standard parts, please contact our sales dept.
- Operating Temperature Range : -55℃ ~ +155℃
- Type QR0402/0603/0805/1206/1210/1812/2010/2512 1Ω ≤ R < 10Ω optional code 「7」 is TCR: ±200PPM

Type	0402	0603	0805	1206	1210	1812	2010	1218	2512
Jumper Resistance Value	50mΩ Max								
Jumper Rated Current	1A				2A				



QR Series Automotive Chip Resistor Product Specifications

Document No.	S-10-12-20-07
Revision Date	2020/05/06
Page No.	3/13

● Automotive Low Ohm Chip Resistor
 ■ Standard Electrical Specifications

Item Type	Rated Power at 70°C	Rated Voltage Range	Max Overload Voltage	T.C.R. (PPM/°C)	Resistance Range (mΩ)
					F(±1%)、J(±5%)
QR0402	0.063 W	0.12~0.25V	0.624 V	±1000	220 ≤ R ≤ 450
				±800	450 < R < 1000
QR0603	0.1 W	0.09~0.31V	0.775 V	±1000	75 ≤ R < 100
				±800	100 ≤ R ≤ 330
				±600	330 < R < 1000
QR0805	0.125 W	0.04~0.35V	0.875 V	±1800	10 ≤ R < 50
				±800	50 ≤ R < 100
				±600	100 ≤ R < 1000
QR1206	0.25 W	0.05~0.5V	1.25 V	±1800	10 ≤ R < 50
				±800	50 ≤ R < 100
				±600	100 ≤ R < 1000
QR1210	0.5 W	0.07~0.7V	1.75 V	±1800	10~50
				±800	51~100
				±600	101~990
QR1812	0.75 W	0.08~0.8V	2.15 V	±1800	10 ≤ R < 50
				±800	50 ≤ R < 100
				±600	100 ≤ R < 1000
QR2010	0.75 W	0.08~0.8V	2.15 V	±1800	10 ≤ R < 50
				±800	50 ≤ R < 100
				±600	100 ≤ R < 1000
QR2512	1 W	0.1~0.99V	2.475V	±1800	10 ≤ R < 50
				±800	50 ≤ R < 100
				±600	100 ≤ R < 1000

- For non-standard parts, please contact our sales dept.
- Operating Temperature Range : -55°C ~ +155°C.



QR Series Automotive Chip Resistor Product Specifications

Document No.	S-10-12-20-07
Revision Date	2020/05/06
Page No.	4/13

● Automotive High Ohm Chip Resistor

■ Standard Electrical Specifications

Item Type	Rated Power at 70°C	Max Working Voltage	Max Overload Voltage	T.C.R. (PPM/°C)	Resistance Range	
					F(±1%)	J(±5%)
QR0402	0.063 W	50V	100V	±200	10.1 MΩ ~ 30 MΩ	10.1 MΩ ~ 30 MΩ
QR0603	0.1 W	75V	150V			
QR0805	0.125 W	150V	300V			
QR1206	0.25 W	200V	400V			
QR1210	0.5 W					
QR1812	0.75 W					
QR2010	0.75 W					
QR2512	1 W					

- For non-standard parts, please contact our sales dept.
- Operating Temperature Range : -55°C ~ +155°C.

■ **Type Dimension**

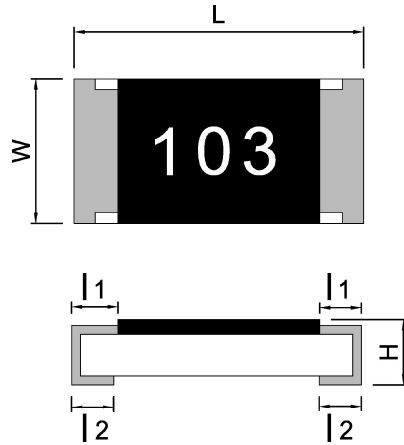

QR0402 / QR0603 / QR0805 / QR1206 / QR1210 / QR1812 / QR2010 / QR2512

■ **Dimension**

Unit: mm

TYPE	L	W	H	l ₁	l ₂
QR0402	1.00 ± 0.10	0.50 ± 0.05	0.30 ± 0.05	0.15 ± 0.10	0.20 ± 0.10
QR0603	1.60 ± 0.20	0.80 ± 0.15	0.40 ± 0.10	0.30 ± 0.20	0.30 ± 0.10
QR0805	2.00 ± 0.20	1.25 ± 0.15	0.50 ± 0.15	0.30 ± 0.15	0.40 ± 0.15
QR1206	3.05 ± 0.10	1.60 ± 0.20	0.55 ± 0.15	0.40 ± 0.20	0.50 ± 0.20
QR1210	3.05 ± 0.10	2.50 ± 0.20	0.55 ± 0.15	0.50 ± 0.20	0.50 ± 0.20
QR1812	4.50 ± 0.10	3.10 ± 0.20	0.55 ± 0.05	0.55 ± 0.20	0.70 ± 0.20
QR2010	5.00 ± 0.20	2.50 ± 0.20	0.55 ± 0.10	0.60 ± 0.20	0.60 ± 0.20
QR2512	6.30 ± 0.20	3.20 ± 0.20	0.55 ± 0.10	0.60 ± 0.20	0.60 ± 0.20



QR Series Automotive Chip Resistor Product Specifications

Document No.	S-10-12-20-07
Revision Date	2020/05/06
Page No.	6/13

● General Information

■ Recommend Land Pattern Design

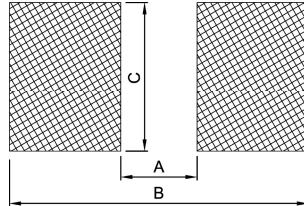

■ Dimension

Unit: mm

Item \ Type	0201	0402	0603	0805	1206	1210	1812	2010	2512
A	0.25	0.60	0.80	1.30	2.20	2.00	3.11	3.80	4.90
B	1.10	1.60	2.40	2.90	4.20	4.40	5.91	6.60	8.10
C	0.32	0.70	1.00	1.40	1.70	2.70	3.00	2.70	3.40

■ Performance Characteristics

■ Power Derating Curve

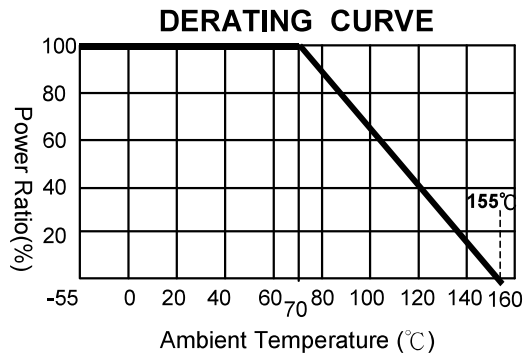

Power rating or current rating is in the case based on continuous full-load at ambient temperature of 70°C. For operation at ambient temperature in excess of 70°C, the load should be derated in accordance with figure of derating Curve.

■ Voltage Rating or Current Rating

Resistance Range: $\geq 1\Omega$

Rated Voltage: The resistor shall have a DC continuous working voltage or a RMS AC continuous working voltage at commercial-line frequency and wave form corresponding to the power rating, as determined formula as following:

$$E(RCWV) = \sqrt{P \times R}$$

E=Rated voltage(V)
P=Power rating(W)
R=Nominal resistance(Ω)



QR Series Automotive Chip Resistor Product Specifications

Document No.	S-10-12-20-07
Revision Date	2020/05/06
Page No.	7/13

● Reliability Test and Requirement

Test Item	Test Method	Procedure	Requirements
Temperature Coefficient of Resistance (T.C.R)	JIS-C-5201-1 4.8 IEC-60115-1 4.8	At 25 / -55°C and 25°C /+155°C, 25°C is the reference temperature	As Spec
Short Time Overload	JIS-C-5201-1 4.13 IEC-60115-1 4.13	2.5 times RCWW or Max. Overload voltage whichever is less for 5 seconds.	±1 : ±(1.0%+0.05Ω) ±5 : ±(2.0%+0.1Ω) Value <1Ω : ±(2.0%+0.1Ω)
Leaching	JIS-C-5201-1 4.18 IEC-60068-2-58 8.2.1	260±5°C for 30 seconds.	Individual leaching area ≤5% Total leaching area ≤ 10%
Resistance to Soldering Heat	JIS-C-5201-1 4.18 IEC-60115-1 4.18	260±5°C for 10 seconds.	±1 : ±(0.5%+0.05Ω) ±5 : ±(1.0%+0.05Ω) Value <1Ω : ±(1.0%+0.05Ω)
Insulation Resistance	JIS-C-5201-1 4.6 IEC-60115-1 4.6	Apply 100VDC for 1 minute.	≥ 10GΩ
Temperature Cycling	JESD22 Method JA-104	1000 Cycles (-55°C to +125°C) Measurement at 24±4 hours after test conclusion. 30min maximum dwell time at each temperature extreme.	1% : ±(0.5%+0.05Ω) 5% : ±(1.0%+0.10Ω)
Resistance to Solvent	MIL-STD-202 Method 215	Add Aqueous wash chemical - OKEM Clean or equivalent.	1% : ±(0.5%+0.05Ω) 5% : ±(0.5%+0.05Ω)
Biased Humidity	MIL-STD-202 Method 103	1,000 hours; 85°C / 85% RH, 10% of operating power. Measurement at 24±4 hours after test conclusion.	1% : ±(1.0%+0.05Ω) 5% : ±(3.0%+0.05Ω)
High Temperature Exposure (Storage)	MIL-STD-202 Method 108	1000 hrs. @ T=125°C. Unpowered. Measurement at 24±4 hours after test conclusion.	1% : ±(0.5%+0.05Ω) 5% : ±(2.0%+0.05Ω)
Operational Life	MIL-STD-202 Method 108	Condition D Steady State TA=125°C at derated power.Measurement at 24±4 hours after test conclusion.	1% : ±(1.0%+0.05Ω) 5% : ±(3.0%+0.10Ω)
External Visual	MIL-STD-883 Method 2009	Electrical test not required. Inspect device construction, marking and workmanship.	—
Mechanical Shock	MIL-STD-202 Method 213)Test ½ Sine Pulse, Peak value: 100g, normal duration: 6ms, Velocity change:12.3ft/sec. 10 shocks in each direction, total30 shocks.	±1 : ±(1.0%+0.05Ω) ±5 : ±(2.0%+0.1Ω)
Vibration	MIL-STD-202 Method 204	5 g's for 20 min., 12 cycles each of 3 orientations. Note: Test from 10-2000 H	±1 : ±(1.0%+0.05Ω) ±5 : ±(2.0%+0.1Ω)
ESD	AEC-Q200- 002 or ISO/DIS 10605	Human body model 0402 / 0603 : 1KV 0805 and above : 2KV	±(3%+0.05Ω)
Solderability	J-STD-002	(1) 4 hrs 155°C dry heat (2) 245±5°C 3 sec.	±1 : ±(0.5%+0.05Ω) ±5 : ±(1.0%+0.05Ω)
Terminal Strength (SMD)	AEC Q200-006	Pressurizing force for 60 seconds 0402 / 0603 : 8N ; 0805 and above : 17.7N	No broken
Board Flex	AEC Q200-005	Beading once for 60 seconds 2010, 2512 sizes: 2mm Other sizes: 3mm	±1 : ±(1.0%+0.05Ω) ±5 : ±(1.0%+0.05Ω)



QR Series Automotive Chip Resistor Product Specifications

Document No.	S-10-12-20-07
Revision Date	2020/05/06
Page No.	8/13

Recommended Customer Soldering Parameters

Wave solder Temperature condition

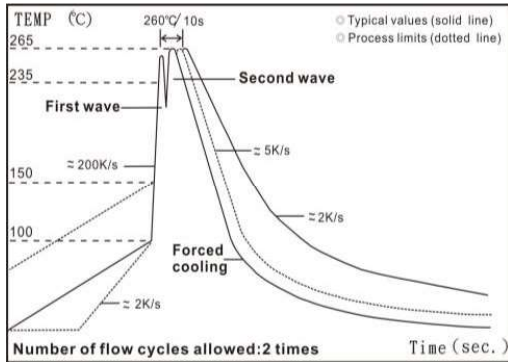

Solder reflow Temperature condition

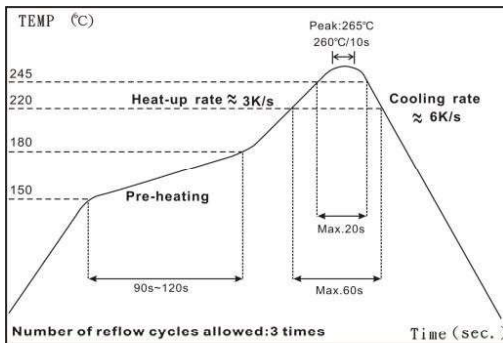

■ Rework temperature (hot air equipment) : 350°C, 3~5seconds

Recommended reflow methods

IR, vapor phase oven, hot air oven

If reflow temperatures exceed the recommended profile, devices may not meet the performance requirements.



QR Series Automotive Chip Resistor Product Specifications

Document No.	S-10-12-20-07
Revision Date	2020/05/06
Page No.	9/13

■ Appendix For SMD Chip Resistor

● Packaging Information

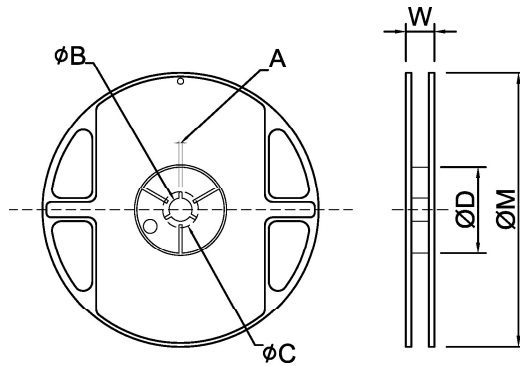

■ Dimension

Unit:mm

TYPE	SIZE		A	φB	φC	φD	W	φM
0402	7"	10K/Reel	2.0±0.5	13.5±1.0	21±1.0	60±1.0	11.5±2.0	178±2.0
	13"	40K/50K Reel	2.0±0.5	13.5±1.0	21±1.0	100±1.0	11.5±2.0	330±2.0
0603/0805/1206/ 1210	7"	5K/Reel	2.0±0.5	13.5±1.0	21±1.0	60±1.0	11.5±2.0	178±2.0
0603/0805 /1206	10"	10K/Reel	2.0±0.5	13.5±1.0	21±1.0	100±1.0	11.5±2.0	254±2.0
	13"	20K/Reel	2.0±0.5	13.5±1.0	21±1.0	100±1.0	11.5±2.0	330±2.0
2010/2512/1812	7"	4K/Reel	2.0±0.5	13.5±1.0	21±1.0	60±1.0	16.0±2.0	178±2.0



QR Series Automotive Chip Resistor Product Specifications

Document No.	S-10-12-20-07
Revision Date	2020/05/06
Page No.	10/13

■ Tapping Specification

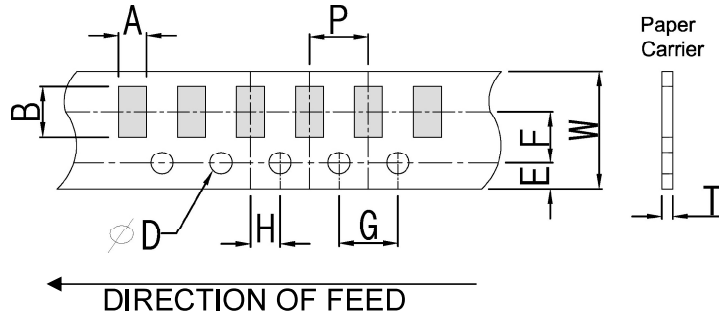

■ Dimension

Unit:mm

Packaging	Type	A	B	W	E	F	G	H	T	ϕD	P
Paper Type	0402	0.70±0.1	1.20±0.1	8.0±0.2	1.75±0.1	3.5±0.05	4.0±0.1	2.0±0.05	0.45±0.1	1.50 ^{+0.10} ₋₀	2.0±0.1
	0603	1.05±0.2	1.80±0.2	8.0±0.2	1.75±0.1	3.5±0.05	4.0±0.1	2.0±0.05	0.60±0.1		4.0±0.1
	0805	1.55±0.2	2.30±0.2	8.0±0.2	1.75±0.1	3.5±0.05	4.0±0.1	2.0±0.05	0.75±0.1		4.0±0.1
	1206	1.90±0.2	3.50±0.2	8.0±0.2	1.75±0.1	3.5±0.05	4.0±0.1	2.0±0.05	0.75±0.1		4.0±0.1
	1210	2.85±0.2	3.50±0.2	8.0±0.2	1.75±0.1	3.5±0.05	4.0±0.1	2.0±0.05	0.75±0.1		4.0±0.1

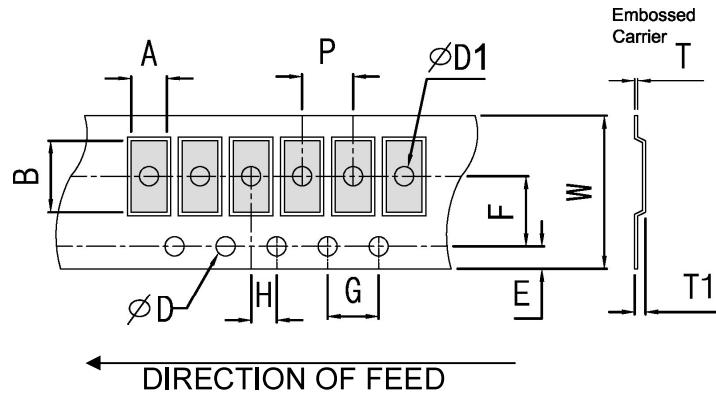

■ Dimension

Unit:mm

Packaging	Type	A	B	W	E	F	G	H	T	ϕD	$\phi D1$	T1	P
Embossed Type	2010	2.80±0.2	5.60±0.2	12±0.1	1.75±0.1	5.5±0.05	4.0±0.1	2.0±0.05	0.23±0.1	1.50 ^{+0.10} ₋₀	1.50±0.1	0.85±0.15	4.0±0.1
	2512	3.40±0.2	6.70±0.2	12±0.1	1.75±0.1	5.5±0.05	4.0±0.1	2.0±0.05	0.23±0.1		1.50±0.1	0.85±0.15	
	1812	3.30±0.2	4.60±0.2	12±0.1	1.75±0.1	5.5±0.05	4.0±0.1	2.0±0.05	0.23±0.1		1.50±0.1	0.85±0.15	



QR Series Automotive Chip Resistor Product Specifications

Document No.	S-10-12-20-07
Revision Date	2020/05/06
Page No.	11/13

■ Packing Material Data/Storage Data

■ Front & Back Lead Dimension

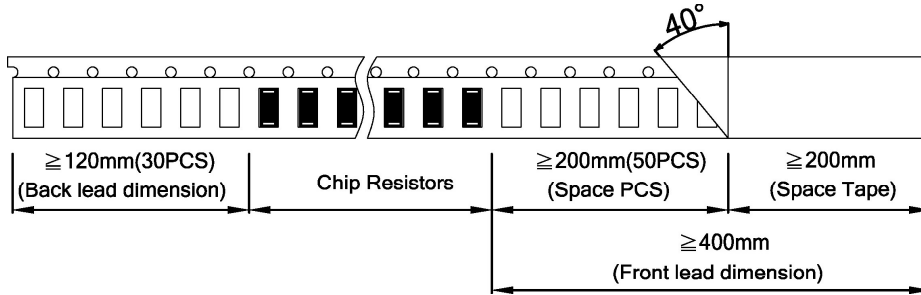

■ Top Adhesive Peel Off Strength : 10~70g

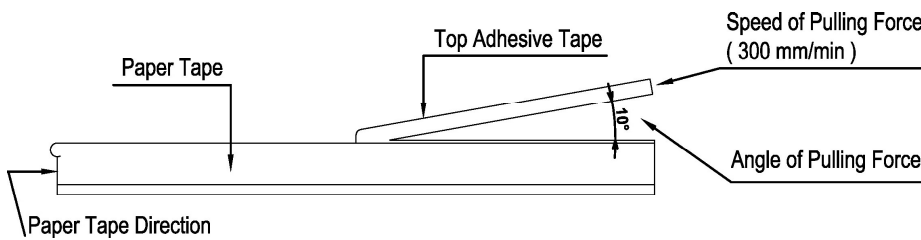

■ Package

Inner Box Size	
Reel	Size H(mm)
1	13
2	24
3	36
5	60
10	113

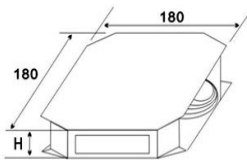

External Box Size			
Contain (Kpcs)	Length (mm)	Width (mm)	Height (mm)
25K	180	180	60
50K	180	180	110
150K	430	200	200
300K	400	400	200

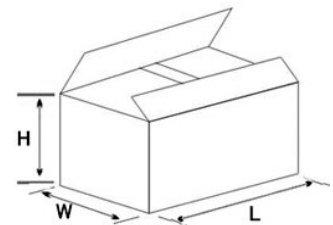

■ Storage Data :

Storage time at the environment temp: $25\pm 5^\circ\text{C}$ & humidity: $60\pm 20\%$ is valid for one year from the date of delivery.

■ Product Testing Method:

Our products are tested with our company's tapping & testing equipments by using four-feet probe to touch at the back of both electrodes. Supposed different testing points or methods are requested, please advise beforehand and customized-made production is available.



QR Series Automotive Chip Resistor Product Specifications

Document No.	S-10-12-20-07
Revision Date	2020/05/06
Page No.	12/13

■ Marking

■ General Resistance Codes



0402: no marking



0603: 3 digits code

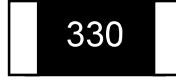

0805~2512: 3 digits code(5%)

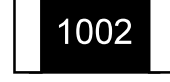

0805~2512: 4 digits code
(1% and below)

■ No marking on 0402 type

■ 3 digits code for 0603 type

● Standard E96 Values and 0603 Resistance Codes

R-Value	100	102	105	107	110	113	115	118	121	124	127	130	133	137	140	143	147	150	154	158	162	165	169	174
Code	01	02	03	04	05	06	07	08	09	10	11	12	13	14	15	16	17	18	19	20	21	22	23	24
R-Value	178	182	187	191	196	200	205	210	215	221	226	232	237	243	249	255	261	267	274	280	287	294	301	309
Code	25	26	27	28	29	30	31	32	33	34	35	36	37	38	39	40	41	42	43	44	45	46	47	48
R-Value	316	324	332	340	348	357	365	374	383	392	402	412	422	432	442	453	464	475	487	499	511	523	536	549
Code	49	50	51	52	53	54	55	56	57	58	59	60	61	62	63	64	65	66	67	68	69	70	71	72
R-Value	562	576	590	604	619	634	649	665	681	698	715	732	750	768	787	806	825	845	866	887	909	931	953	976
Code	73	74	75	76	77	78	79	80	81	82	83	84	85	86	87	88	89	90	91	92	93	94	95	96

● E96 Multiplier Code

Code	A	B	C	D	E	F	G	H	X	Y	Z
Multiplier	10 ⁰	10 ¹	10 ²	10 ³	10 ⁴	10 ⁵	10 ⁶	10 ⁷	10 ⁻¹	10 ⁻²	10 ⁻³

1. 0603 3 digits coding formula for E96 values as following:

CODING FORMULA

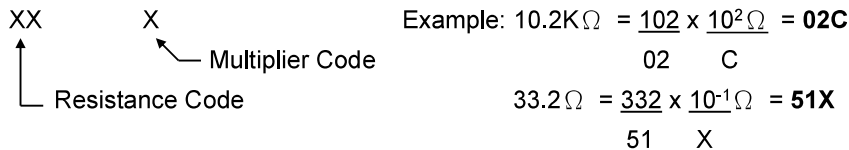

EX.: 7.5Ω=85Y ; 11Ω=05X ; 130Ω=12A ; 2KΩ= 30B ; 10KΩ=01C ; 150KΩ=18D

E24	10	11	12	13	15	16	18	20	22	24	27	30	33	36	39	43	47	51	56	62	68	75	82	91
-----	----	----	----	----	----	----	----	----	----	----	----	----	----	----	----	----	----	----	----	----	----	----	----	----

■ 0603 ~2512 3 digits for E24 values (±5%)

Examples:

Resistance	4.7Ω	33Ω	470Ω	5.6KΩ	62KΩ	680KΩ
3 digits code	4R7	330	471	562	623	684

("R"= decimal point)

■ 4 digits code for 0805 ~ 2512 type

First 3 digits are the significant figures, the 4th digit is the multiplier. "R"= decimal point.

Examples:

Resistance	5.6Ω	10Ω	22.6Ω	100Ω	1.1KΩ	10KΩ	332KΩ	1MΩ
4 digits code	5R60	10R0	22R6	1000	1101	1002	3323	1004



QR Series Automotive Chip Resistor Product Specifications

Document No.	S-10-12-20-07
Revision Date	2020/05/06
Page No.	13/13

■ mΩ Resistance Codes



0402: no marking

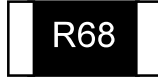

0603: 3 digits

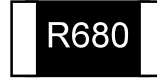

0805~2512: 4 digits

■ 0402 : No marking

■ 0603 : 3 digit marking

1. For E-24 values:

Resistance value	Code	Example
10mΩ ~ 99mΩ	OXX	068 = 68mΩ
100mΩ ~ 990mΩ	RXX	R68 = 680mΩ

E-24	10	11	12	13	15	16	18	20	22	24	27	30	33	36	39	43	47	51	56	62	68	75	82	91
------	----	----	----	----	----	----	----	----	----	----	----	----	----	----	----	----	----	----	----	----	----	----	----	----

2. For E-96 values: excluding values 10/11/13/15/20/75 of E-24 series.

● Standard E-96 Values and 0603 Resistance Codes

R-Value	100	102	105	107	110	113	115	118	121	124	127	130	133	137	140	143	147	150	154	158	162	165	169	174
Code	01	02	03	04	05	06	07	08	09	10	11	12	13	14	15	16	17	18	19	20	21	22	23	24
R-Value	178	182	187	191	196	200	205	210	215	221	226	232	237	243	249	255	261	267	274	280	287	294	301	309
Code	25	26	27	28	29	30	31	32	33	34	35	36	37	38	39	40	41	42	43	44	45	46	47	48
R-Value	316	324	332	340	348	357	365	374	383	392	402	412	422	432	442	453	464	475	487	499	511	523	536	549
Code	49	50	51	52	53	54	55	56	57	58	59	60	61	62	63	64	65	66	67	68	69	70	71	72
R-Value	562	576	590	604	619	634	649	665	681	698	715	732	750	768	787	806	825	845	866	887	909	931	953	976
Code	73	74	75	76	77	78	79	80	81	82	83	84	85	86	87	88	89	90	91	92	93	94	95	96

● E-96 Multiplier Code

Code	A	B	C	D	E	F	G	H	X	Y	Z
Multiplier	10 ⁰	10 ¹	10 ²	10 ³	10 ⁴	10 ⁵	10 ⁶	10 ⁷	10 ⁻¹	10 ⁻²	10 ⁻³

● 0603 3 digits coding formula for E-96 values as following:

CODING FORMULA

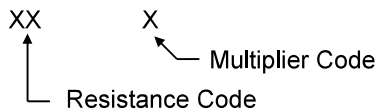

Example: $499 \text{ m}\Omega = 499 \times 10^{-3} \Omega = \mathbf{68Z}$

68 Z

■ 0805~2512 : 4 digit marking

1. For E-24 values:

Resistance value	Code	Example
10mΩ ~ 990mΩ	RXXX	R680 = 680mΩ

■ Note: jumper zero ohm resistor marking code is one 「0」 (except type below 0402).